



## *Patient Warming Systems*

# Service Manual

**Inditherm Medical  
Houndhill Park  
Bolton Road  
Rotherham  
S63 7LG**

**Tel: +44 (0) 1709 761000  
Fax: +44 (0) 1709 761066  
e-mail: [info@indithermplc.com](mailto:info@indithermplc.com)**

**[www.inditherm.com/medical](http://www.inditherm.com/medical)**

©Inditherm plc 2007



0473

<b>Contents:</b>		<b>Page</b>
Warnings		3
Introduction		4
Product Range		5
System Description		6
Fault Finding		8
Repairs		11
Mattress/Blanket		
Mattress/Blanket connector		11
Control cable		
Control cable connectors		11
Control Unit		14
Clamp assembly		14
Display PCB		14
Case upper half		14
Output fuse		15
Control PCB assembly		15
Transformer assembly		15
Power on/off switch		16
Mains power cable		16
Control Cable		17
Case lower half		19
Testing		
Control Unit		20
Mattress/Blanket		21
System Test		22
Spare Parts List		23
Technical Specification		25

© Inditherm plc, 2007

Copyright: All rights reserved. No part of this handbook may be reproduced, stored in a retrieval system or transmitted in any form or by any means electronic, mechanical, photocopying, recording or otherwise, without the prior permission of Inditherm plc.

## **WARNINGS:**

Any person carrying out repairs or service should have received adequate training and be competent to carry out the work.

The control unit should be disconnected from the mains supply before the covers are removed.

All work should be carried out with the equipment disconnected from the mains supply wherever possible.

This Service Manual should be read in conjunction with the Operating Instructions for the system.

It is recommended that the unit is cleaned and decontaminated prior to handling, unless a decontamination certificate or statement that the system is free of hazard is supplied.

## INTRODUCTION:

This Service Manual is for use by qualified engineers and technicians only. Servicing carried out by any person other than authorised Inditherm engineers will invalidate any warranty on the system.



The Inditherm Patient Warming Systems are designed for use in the operating room, recovery room, anaesthetic room and accident & emergency department. They provide safe and controlled warming to assist patients to maintain normal body temperature. The warming medium is available as:

- A mattress for use under a patient
- A recovery blanket or operating room blanket to be placed over a patient on a bed or trolley.

Different sizes and models of mattress and blanket are available for various procedures and situations. Mattresses are sealed to prevent ingress of fluids and allow cleaning. Integral straps are provided to ensure mattresses can be securely fastened to the operating table or trolley.

The system is powered and controlled by an electronic control unit. The mattresses and blankets are powered at low voltage, ensuring safety for patients and operators. The temperature is controlled automatically to user-selected level. An over-temperature safety cut-out is integrated into each mattress and blanket.

The control unit is powered from a standard mains supply input and produces a nominal working output of 24Vac to the mattress or blanket. The system has 4 pre-set operating temperatures of 37, 38, 39 and 40°C and is designed to be operated continuously, maintaining a uniform heat under the patient.

**PRODUCT RANGE:**

Note: Any mattress or blanket can be used with any control unit, but is limited to only **one** mattress or blanket per unit.

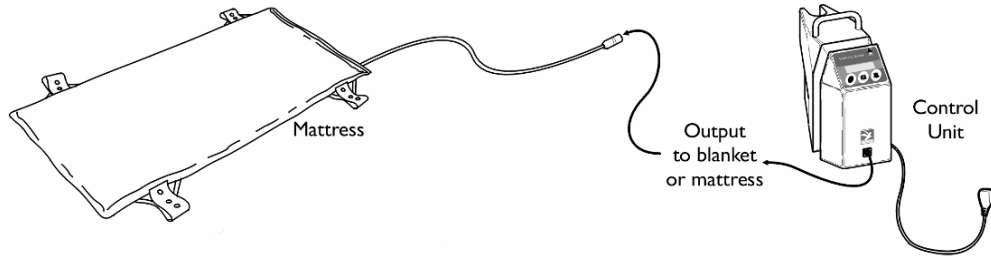

Model	Size	Description
OTM1	1900 x 585 x 40 mm	Operating Room Mattress, Full Length
OTM1-N	1900 x 535 x 40 mm	
OTM2	1200 x 585 x 40 mm	Operating Room Mattress, ¾ Length
OTM2-N	1200 x 535 x 40 mm	
GTM1	1070 x 585 x 40 mm	Operating Room Gynaecology Mattress
GTM1-N	1070 x 535 x 40 mm	
PTM1	560 x 500 x 40 mm	Operating Room Paediatric Mattress
OTB1	500 x 1070 x 40 mm	Operating Room Blanket
OTB2	500 x 870 x 40 mm	Operating Room Blanket
RB1	1660 x 800 x 40 mm	Recovery Room Blanket
RB2	1660 x 1200 x 40 mm	Recovery Room Blanket
MECU1	160 x 240 x 230 mm	Electronic Control Unit

## SYSTEM DESCRIPTION:

### Control Unit

The control unit is a precision temperature controller to be used in conjunction with an Inditherm warming mattress or blanket.

The control unit comprises a single case, with integral clamp, containing mains power inlet, mains fuse, transformer, control PCB, display and controls.

On the front of the unit is a display and control panel from which all the functions can be accessed, there are three control buttons, and an LCD display. A captive cable for connection to the mattress or blanket is hard wired through the front face of the unit.



The control unit provides a 24Vac supply to the mattress or blanket and receives temperature information back. The control unit output is protected by a 1600mA fuse, which is accessible from the base of the unit. The controller automatically adjusts to the type of mattress or blanket connected.

The control unit takes signals from the temperature sensor in the mattress or blanket and the readings are used to control the power output and alert the user to over and under temperature faults.

Control panel layout is as shown. For function of controls, and display parameters, please see Operating Instructions

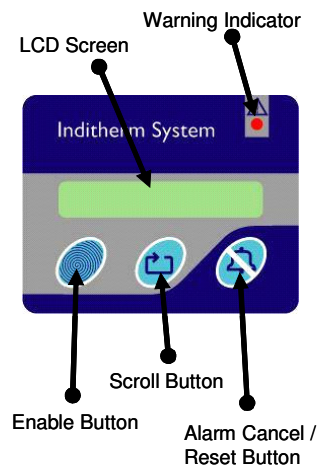

## Mattresses

Mattresses are available in various sizes and are only designed to operate under the patient. The mattress provides an even temperature over the whole surface and is extremely flexible.

The basic construction of the mattresses remains the same throughout the range. The mattresses are water and solvent resistant and have been tested for bio-compatibility to allow skin contact during use. All seams are fully sealed by RF welding.

The internal patented Inditherm carbon polymer material provides the heat source, and internal temperature sensor provides the output to the control unit for temperature control. The mattress has a thermal cut-out that will not allow the mattress to overheat.

A pressure relief pad is integrated into the mattress, underneath the flexible warming surface. This prevents pressure sores without any attenuation of the warming performance.

Straps are used to retain the mattress in-situ and it is important that the mattress is securely fastened to the operating table or trolley.



## Blankets

Blankets are designed to operate over the patient. There are two types of blanket available, one for the operating room and the other for areas such as recovery room, intensive care unit, etc. The operating room blankets are constructed in the same manner as the mattresses, but without the pressure relief pad. The recovery blanket has lighter outer material and stitched seams.



## FAULT FINDING:

### General Performance

On initial start up, if the ambient temperature is low, the mattress/blanket will take longer to achieve the desired temperature. If the desired temperature is not achieved within 40 minutes the alarm will sound. Should this happen select the reset/alarm button and the unit will restart and the system will allow another 20 minutes for the desired temperature to be achieved.

The control unit will power the mattress/blanket and monitor temperature performance. Once the mattress/blanket reaches the desired temperature the control unit will adjust power input to ensure the desired temperature is maintained. If the maximum allowed temperature is achieved the over temperature alarm will sound. If the alarm is activated select reset/alarm button and the unit will restart. An internal safety cut-out temperature management system will ensure the mattress/blanket will never achieve a temperature greater than 43°C under any fault condition.

When the system is powered on it should follow the cycle below. In case of any error messages or other faults, refer to the Fault Finding chart.

Display Screen Readout	Action Required	Information
		Bleep will be heard on switch on
<b>Inditherm V2.03E</b>	None	First screen indicating initialisation started
<b>English UK &gt; to change language</b>	Option to change Language See <b>Control Instructions</b>	For <b>UK users</b> , take <b>no action</b> and system will automatically continue
		Bleep will be heard
<b>Language English UK</b>	None	Screen Indicates Language
		Bleep will be heard
<b>System Check</b>	None	Automatic system test
		Bleep will be heard
<b>System OK</b>	None	User indication that system is OK
		Bleep will be heard
<b>Alarm Check</b>	None	Automatic test of alarm sound
		Bleep will be heard
<b>Alarm OK</b>	None	User indication that alarm ok
		Bleep will be heard
<b>^ 37 °C ^</b>	User can change temperature set	Display showing temperature setting. Arrows will point upwards whilst heating up to set temperature.
<b>&gt; 37 °C &lt;</b>	User can change temperature set	Display showing temperature setting. Arrows point horizontal to indicate that set temperature is reached.
<b>∨ 37 °C ∨</b>	User can change temperature set	Display showing temperature setting. Arrows will point downwards to indicate cooling to set temperature.



<b>Fault Finding / Troubleshooting</b>	
<b>Fault or Error Message</b>	<b>Diagnostic Checks</b>
<b>General Procedure:</b>	<ul style="list-style-type: none"> <li>• In most cases the fastest fault diagnosis is achieved by carrying out substitution tests as follows:                             <ul style="list-style-type: none"> <li>– Replace mattress/blanket from faulty system with known working mattress/blanket</li> <li>– Replace control unit from faulty system with known working control unit</li> <li>– When faulty component is identified, substitute it back and check it is still not working, then proceed as described in Repair section</li> </ul> </li> </ul>
<b>Alarm &amp; Error Message:</b> <i>“Connect mattress/blanket”</i>	<ul style="list-style-type: none"> <li>• Check mattress is plugged in correctly. Verify that orientation of plugs/sockets are correct</li> <li>• Check for any visible damage to cable and connectors</li> <li>• Unplug connectors and check that pins on plugs show no sign of being damaged or bent</li> <li>• If none of the above are applicable call supplier for advice</li> </ul>
<b>Alarm &amp; Error Message:</b> <i>“Mattress Fault” (A number will show after message, this is for Inditherm indication only)</i>	<ul style="list-style-type: none"> <li>• Check 6.3A fuse on Control PCB has not blown (see diagram in Repairs section)</li> <li>• If fuse is intact, return mattress to supplier</li> </ul>
<b>Mattress/Blanket warms up but does not reach temperature set</b> <i>“Low Temperature Detected”</i>	<ul style="list-style-type: none"> <li>• Ensure none of the control buttons is stuck, by pressing each button in turn and checking that there is a positive tactile feel and that a click is heard</li> <li>• Ensure the fault does not only occur when the mattress does not have a patient on. The system may not reach target temperature if the mattress is uncovered and the ambient temperature is low</li> <li>• Place the mattress/blanket on a flat surface that is not cold and cover upper surface with a standard blanket. Turn on the system and check that temperature is reached within 15 minutes. If this works then system is functioning normally and fault is due to local operating conditions, such as ambient temperature or cold surface</li> <li>• Reduce set temperature to 37°C, cover mattress with a blanket and check that temperature is reached within 15 minutes. Increase temperature setting to required level and check temperature is reached. If this works then system is functioning normally and fault is due to local operating conditions, such as ambient temperature or cold surface</li> <li>• Run unit in Test mode (see section Testing the System) and check that the temperature is increasing</li> <li>• If problems persist, contact supplier and advise operating conditions, including ambient temperature from Test Mode</li> </ul>

<b>Fault Finding / Troubleshooting</b>	
<b>Fault or Error Message</b>	<b>Diagnostic Checks</b>
<b>Mattress/Blanket does not warm up at all</b>	<ul style="list-style-type: none"> <li>• Check control unit is on and there are no error messages</li> <li>• Disconnect the mattress/blanket from the control unit and check there is an output of 23Vac <math>\pm 6\%</math> from inside the control unit between the two black wires (0V &amp; 24Vac) on the transformer connector to the PCB. (see diagram in Repair section).</li> <li>• If there is no 23V output, check cable as described in Repair section.</li> <li>• If cable is not faulty carry out diagnostic checks as described below for “Control Unit display is blank”</li> <li>• Run unit in Test mode (see section Testing the System) and check that the temperature is increasing.</li> <li>• If problems persist, contact supplier and advise operating conditions, including ambient temperature from Test mode</li> </ul>
<b>Control Unit display is blank</b>	<ul style="list-style-type: none"> <li>• Check control unit switch is set to On and is illuminated. If switch not illuminated check fuse in mains plug (if fitted). If fuse not blown check mains input wiring as described in Repair section</li> <li>• Check 1600mA external fuse on bottom of unit (see diagram in Repairs section)</li> <li>• Check transformer connector is correctly installed onto Control PCB (see diagram in Repairs section)</li> <li>• Check output voltage of transformer is 23Vac <math>\pm 6\%</math>. If output is correct check input to transformer is at mains voltage.</li> <li>• Check transformer connector is correctly fitted onto Control PCB</li> <li>• Check ribbon cable connector is correctly fitted onto Control PCB</li> <li>• Ensure none of the control buttons is stuck, by pressing each button in turn and checking that there is a positive tactile feel and that a click is heard</li> </ul>

## REPAIRS:

### Mattress/Blanket Plug (PS3):

Please follow sequence shown for assembling socket once wires have been connected as per Diagram 1.

Note: individual cable insulation is numbered.

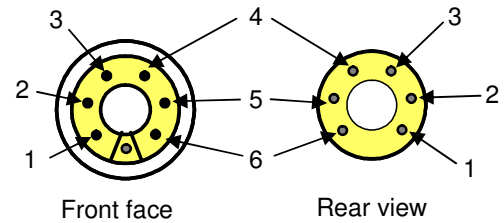

Diagram 1: Connections for PS3

Study how the connector is assembled before attempting to replace it. Diagram 3 shows how the connector parts are assembled.

Each connector has multiple components to it, thus making it imperative that each piece is correctly put together. Failure to do so may cause damage to the mattress/blanket or control unit.

*Due to improvements in design, not all systems are the same. Identify the build type of your system to ascertain which of these instructions are applicable.*

### Connector Socket (PS5)

Please follow sequence below for assembling socket once wires have been connected as per Diagram 2.

Note: individual cable insulation is numbered.

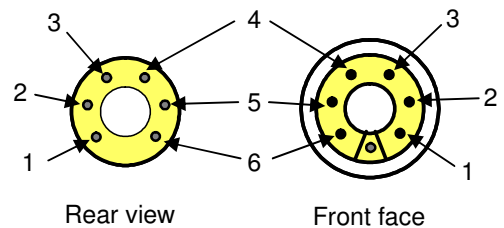

Diagram 2: Connections for PS5

Study how the connector is assembled before attempting to replace it. Diagram 4 shows how the connector parts are assembled.

Each connector has multiple components to it, thus making it imperative that each piece is correctly put together. Failure to do so may cause damage to the mattress/blanket or control unit.

### Diagram 3: Assembly for PS3



Ensure all the parts are assembled in the correct order as shown above.

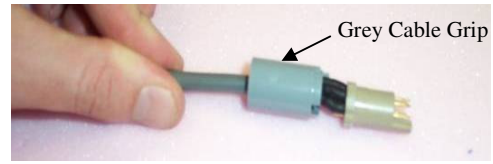

Once the 5 wires are soldered & insulated correctly, slide the grey cable grip up to the plug insert.

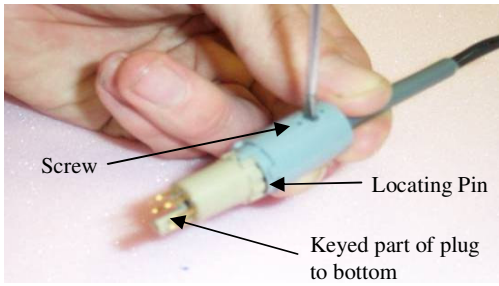

The cable grip has a locating pin which should be sat in the top groove of the plug insert. The keyed part of the plug should be at the bottom, meaning the locating pin and screw are in line with each other. Tighten the screw to grip the cable.

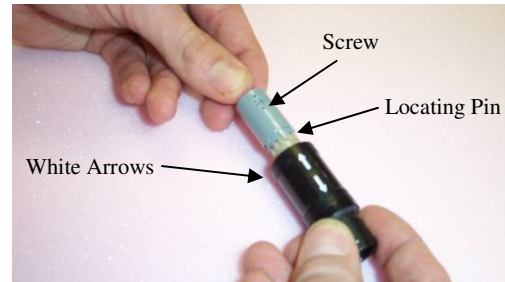

The screw and the locating pin should be in line with the white arrows on the plug housing. Push the plug insert into the housing until a "click" is heard. This means it is in place correctly. This must stay in place for the rest of the plug to be assembled correctly.



Once the insert is inside the housing, slide the blue ring down the cable up to the grey cable grip.



Slide the grey washer ring up to the blue ring.



Slide the collet up to meet the black casing.



Screw the collet to the plug housing until hand tight.



Tighten up using the collet spanner.



The plug is now complete

### Diagram 4: Assembly for PS5



Please note correct order of parts for complete assembly.



Once the wires are soldered and insulated correctly, slide the grey piece down the cable.

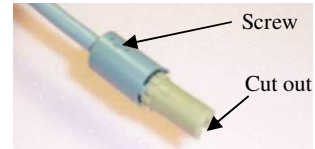

Ensure the grey cable grip is pushed up to the socket insert and that no wires are visible. Ensure the screw is facing upwards and the cut out part of the socket is underneath.

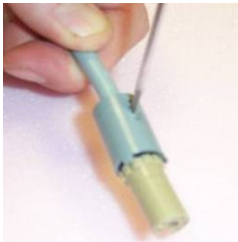

Tighten the screw so the cable is gripped tight.

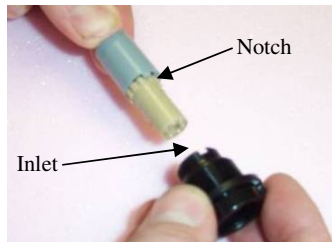

Place the socket insert into the outer shell housing, fit the housing so that the small notch fits into the inlet as shown.



Holding all parts together slide the blue ring up to the grey cable grip.



Next slide the grey washer up to the blue ring.



Ensuring all parts are held together slide over the collet and screw into housing.



Once hand tight use the collet spanner to tighten.



Using a multipurpose silicon lubricant, lightly spray around the blue ring.



Now slide the outer case over the blue ring and screw to the front housing.



The socket is now complete, if required tighten outer casing with a suitable sized spanner.

## Control unit repairs

### Ensure power is switched off & unplugged before opening the case

Open the case by removing five cross-head (Pozi) screws on underside of case as shown.

Lift upper half of case upwards to separate from lower half. Remove connector that connects ribbon cable from Display PCB (located in upper case half) to Control PCB (in lower case half) at the left side of the Control PCB. This separates the upper and lower case halves.

Note: of the five screws, the top screw as pointed out above is shorter than the other four and requires a long nose screw driver (Pozi) drive

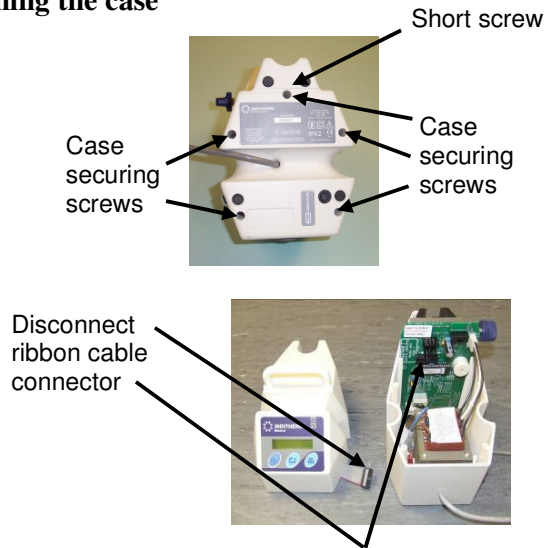

### Replacing Clamp (MA4):

When the upper case half has been removed, the clamp mechanism may simply be lifted out from the upper case housing. When replacing the upper or lower case half, the clamp mounting plate must also be removed.

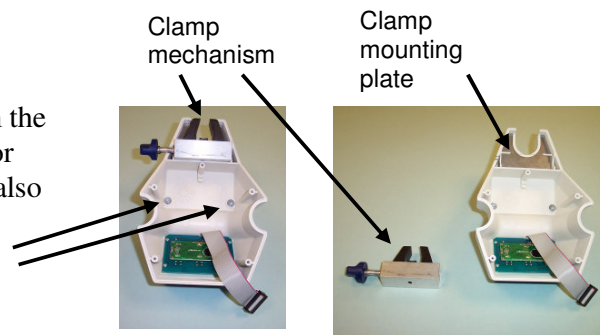

### Replacing Display PCB Assembly (EA4):

Remove the four screws retaining the Display PCB into the case upper half. Observing anti-static precautions when handling the circuit board, remove it from the case.

Replace by reversing the above procedure.

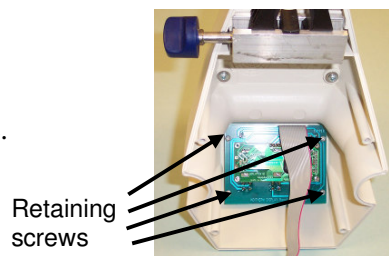

### Replacing Case Upper Half (MA2):

To replace the case upper half, remove clamp, clamp mounting plate, unscrew handle and Display PCB as described above, and re-fit components to new case.

**Replacing Control Board Output Fuse (FU1):**

The output fuse, FU1, can be replaced without removing the Control PCB from the case lower half. Remove the fuse from the plastic holder and replace with same rating.

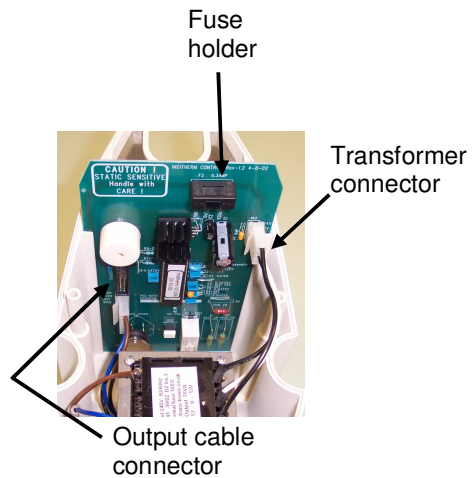

**Replacing Control PCB Assembly (EA3):**

Disconnect the transformer and the output cable from the PCB by un-plugging the two connectors. Observing anti-static precautions when handling the circuit board, slide it upwards in the guide slots to remove it from the case.

Replace by reversing the above procedure.

**Replacing Transformer Assembly (TR1):**

Disconnect the transformer from the Control PCB by removing the transformer connector as shown above. Remove the four retaining screws, noting the position and orientation of the mounting insulators under the lower rear side of the transformer for later re-assembly.

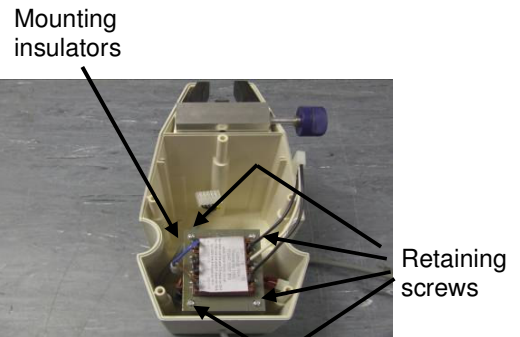

Lift the transformer from its mountings and place carefully beside the case, ensuring there is no strain on the connecting wires, as shown.

Remove the cable loom plastic spiral binding, after noting how the cables are retained for later re-assembly.

Remove the transformer input connections from the mains on/off switch by pulling the crimp connectors off, taking note of the cable orientation.

Replace by reversing the above procedure, taking care to ensure connection orientations are correct, the cable loom binding is replaced and the mounting insulators are correctly positioned.

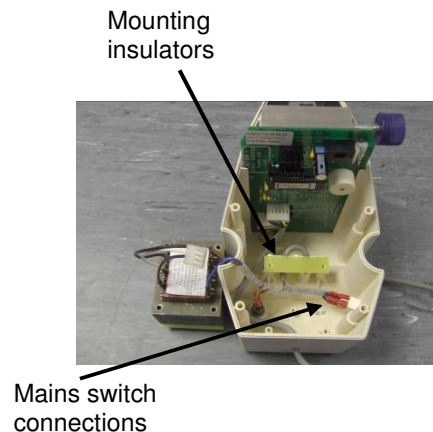

### Replacing Power On/Off Switch (SW1):

Remove the transformer as described above.

Remove the remaining connections from the mains on/off switch by pulling the crimp connectors off, taking note of the cable orientation.

Press down and hold the retaining tab on the top of the switch and push the switch outward through the case.

Replace by reversing the above procedure, taking care to ensure connection orientations are correct.

### Replacing Mains Power Cable (EA1):

Remove the transformer as described above.

Remove the input connections from the mains on/off switch and the fuse holder by pulling the crimp connectors off, taking note of the cable connections.

Cut off the crimp terminals and lift the cable from the retention slots to allow the cable to be pulled out through the cable entry. Remove the cable.

Pass the new cable through the entry in the bottom of the case. Strip back the outer insulation and prepare the wires. Note that the system is double insulated and patient isolated Type BF, therefore the earth connector is not used and should be cut off flush with the outer insulation. Crimp on the terminals and attach them in the same locations as the removed cable. Pull any excess cable back through the entry and retain the cable in the slots provided, as shown.

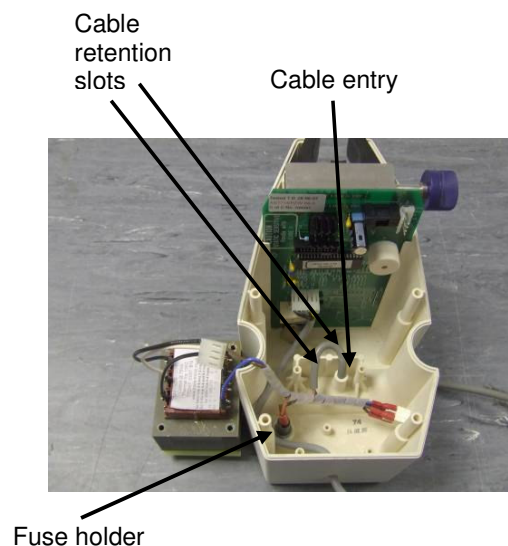



### Replacing Control Cable (EA6):

Open the case by removing the 5 screws underneath the control unit as per Control Unit Repairs Section.

Remove the top half of the case by disconnecting the display board ribbon cable from the main printed circuit board (PCB).

Remove the transformer by removing the 4 screws as per Replacing the Transformer Section.

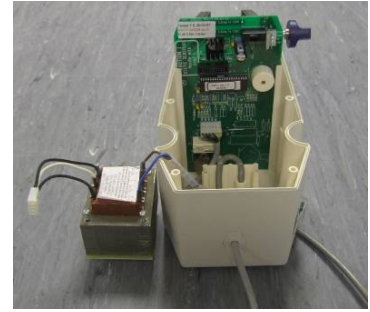

Slide out the PCB and remove it from the bottom half of the case completely.



Using a pair of sharp side cutters, cut off the end of the hardwire cable inside the case, so that the plastic housing is removed.



Make sure the plastic housing is discarded as this will be replaced with a new one accompanied with the hardwire kit.

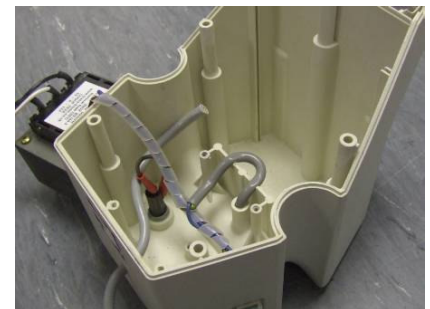

Using a pair of long nose pliers, squeeze together the side tabs on the inside of the plastic insert as shown.

This will enable the insert to “pop” out, thus enabling the rest of the hardwire cable to be pulled through, and out of the case.



Pull the entire cable out of the case.

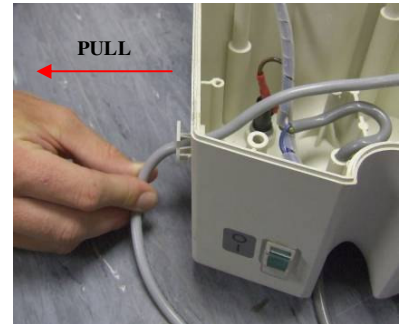

Using the new moulded insert from the kit, push into the front of the case until flush with the front of the case, and the 2 prongs have clicked into position inside the case so it cannot be pushed out.

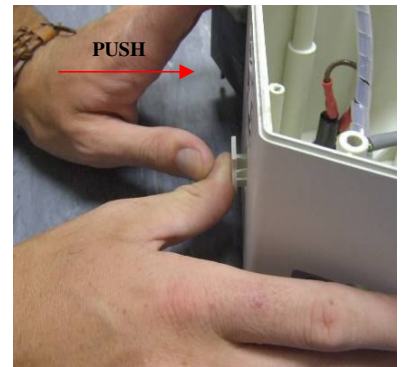

Shown on the right is the correct way of how the insert should look once inserted.

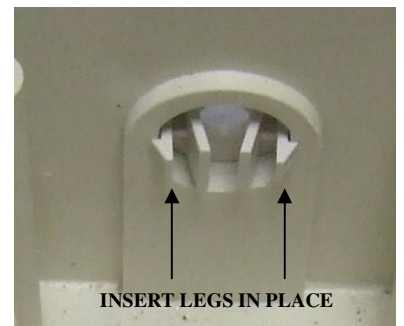

Once the insert is pushed in correctly, push the new hard wire cable through the hole and route the wire left, around the internal fuse as shown.



Each individual core (numbered 1-4 and earth) will need to be pushed through the hole separately in order for the whole cable to fit through.

Pull the cable through so that the start of the sheathing can touch the back of the case.

Holding the plug housing, lip faced down; push the wires in through the back slots from left to right, numbered 2, 1, 4, 3 and earth in that order left to right respectively.



Once they are inserted, the one way barb should stop the crimp being able to be pulled back out. This is fitted correctly.

Slide the PCB back into the case grooves and connect the hard wire plug housing to the board, lip face down.



NB. Make sure the plug housing is lined up correctly with the pins on the PCB.

Wire 2 should be on HTR1, wire 1 on HTR2, then 4 on NTC1 and 3 on NTC2. The earth wire should be on the RB pin.

The installation of the hard wire kit is now complete.

The unit can be reassembled and tested to make sure that it works correctly.



Once tested as being correct, screw the unit back together and place back into service for use.

### Replacing Case Lower Half (MA3):

To replace the case lower half, remove transformer, Control PCB, Power on/off switch, output connector and mains power cable as described above. Remove fuse holder and clamp mounting plate and re-fit components to new case.

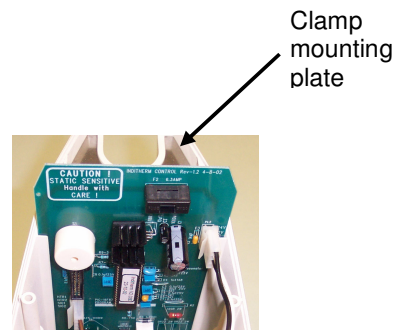

**TESTING THE SYSTEM:****Control Unit Tests:***Equipment required:*

- Inditherm mattress or blanket that is known to be working correctly.
- Control cable (*units without integral cable only*).

*Test Procedure:*

Inspect the outside of the case, power cable and mains plug for any sign of damage. If any damage is found, replace parts as appropriate.

With NO mattress or blanket connected, turn on the control unit. Check that the following occur:

- Power switch illuminates
- Display illuminates and a short beep sounds
- Display shows: “*INDITHERM Vx.xxn*” where “*x.xxn*” must be “*2.03E*” or later
- Unit cycles through checks (see Fault Finding section for details)
- Unit halts displaying “*Connect Mattress/Blanket*”
- Red alarm indicator illuminates
- A constant beep sounds

Connect a mattress or blanket that is known to be working. Check that the following occur:

- Message “*Connect Mattress/Blanket*” disappears
- Alarm indicator is no longer illuminated
- Continuous beep stops sounding
- Unit completes check cycle (see Fault Finding section for details)
- Display shows last temperature set with ^ to indicate warming up (e.g. ^ 40 C ^)

Press and hold Enable and Scroll buttons together and whilst holding press and release Alarm Cancel/Reset button. The unit will re-start in Test Mode.

Allow the unit to cycle through the test sequence to the main menu.

Remove the mattress/blanket connector. Check the following occur:

- Unit halts displaying “*Connect Mattress/Blanket*”
- Red alarm indicator illuminates
- A constant beep sounds

Reconnect the mattress/blanket and check that the following occur:

- Message “*Connect Mattress/Blanket*” disappears
- Alarm indicator is no longer illuminated
- Continuous beep stops sounding

### Mattress/Blanket Test:

This testing procedure will establish that the mattress/blanket is functioning correctly. It is not possible for the user to make accurate temperature measurements by any other means than the procedure below, as these relate to the heating surface itself, which is sealed inside the mattress/blanket. This accurate heating surface measurement is checked during manufacture and at any time the mattress is serviced by Inditherm.

#### Test Procedure:

Press and hold Enable and Scroll buttons together and whilst holding press and release Alarm Cancel/Reset button. The unit will re-start in Test Mode.

Ensure that Page 1 (Temperature Data) of Test Mode is selected; there are four pages as follows:

- Page 1 Temperature Data (This is the only page relevant for temperature testing)
- Page 2 Bad Data
- Page 3 Rail Data
- Page 4 Safety Timers

To move to the correct page if the unit has not defaulted to Page 1; whilst holding Enable button, press and hold Scroll button until the page changes, continue until Page 1 Temperature Data is shown.

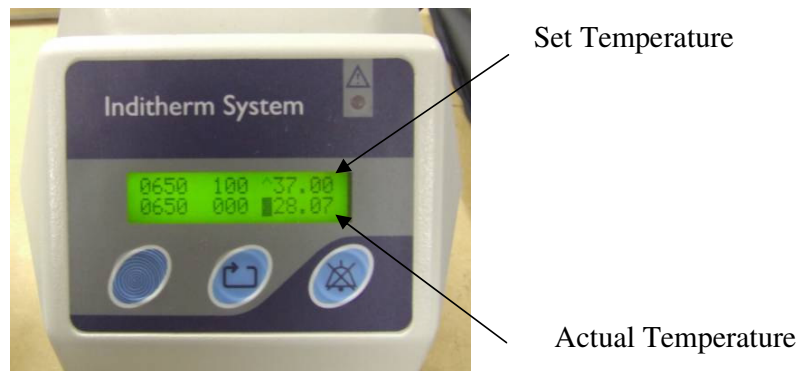

To check the actual temperature of the mattress / blanket against the temperature set there will be two temperatures shown on the screen as follows:

- Top right hand corner is the set temperature
- Bottom right hand corner is the actual temperature of the mattress / blanket

Check that the temperature reading at the bottom right hand corner increases steadily until set temperature has been achieved with a tolerance of  $\pm 1^{\circ}\text{C}$ .

*Please Note:* Whilst in Test Mode, when selecting set temperature, if scroll button is held for too long the Test Mode page will change to Page 2, if this happens follow instructions above to return to Page 1. Also when Test Mode is first selected the temperature will default to the lowest within the range, to change the temperature press and hold enable button and select scroll button in the normal way.

**System Test:**

Connect mattress or blanket to control unit. Turn control unit power switch to On. Check that the system performs start up checks correctly (see Fault Finding section).

Disconnect mattress or blanket and check error message is displayed and alarm sounds.

Re-connect mattress or blanket and check alarm stops sounding, error message is removed and display shows temperature setting.

Perform an insulation breakdown and enclosure leakage (touch current) test and ensure results meet regulation for Class II equipment.

**Spares - Patient Warming Range**

<b>Product Description</b>	<b>Product Code</b>
<b>Spares for Medical Control Unit &amp; Cable</b>	
Case assembly, complete	MA1
Case assembly, Top	MA2
Case assembly, Bottom	MA3
Clamp assembly	MA4
Handle assembly	MA6
Cable, mains power – United Kingdom	EA1 (UK)
Cable, mains power – United States	EA1(US)
Cable, mains power - Australia	EA1(AU)
Cable, mains power – Japan	EA1(JP)
Cable, mains power - Europe	EA1(EU)
Control cable assembly, complete	EA2
Control PCB assembly	EA3
Display PCB assembly	EA4
Black connector & captive cable, hard wire kit	EA6
Black connector for control cable	PS5
Fuse Holder, mains power	PS8
Power switch	SW1
Fuse, T6.3A, control board	FU1
Fuse, T1600mA, mains power	FU2
Transformer assembly	TR1
MECU1 front label	LA1
Fuse label	LA4
Serial Number / Address / CE label	LA5
Power switch label	LA6
<b>Spares for Operating Room Warming Mattresses</b>	
Connector black plug for mattress	PS3
Factory re-cover of OTM1 mattress	SV1
Factory re-cover of OTM2 or GTM1 mattress	SV2
Factory re-cover of PTM1 mattress	SV3
<b>Spares for Operating Room &amp; Recovery Blankets</b>	
Connector black plug for blanket	PS3
Factory re-cover of RB1 blanket	SV4

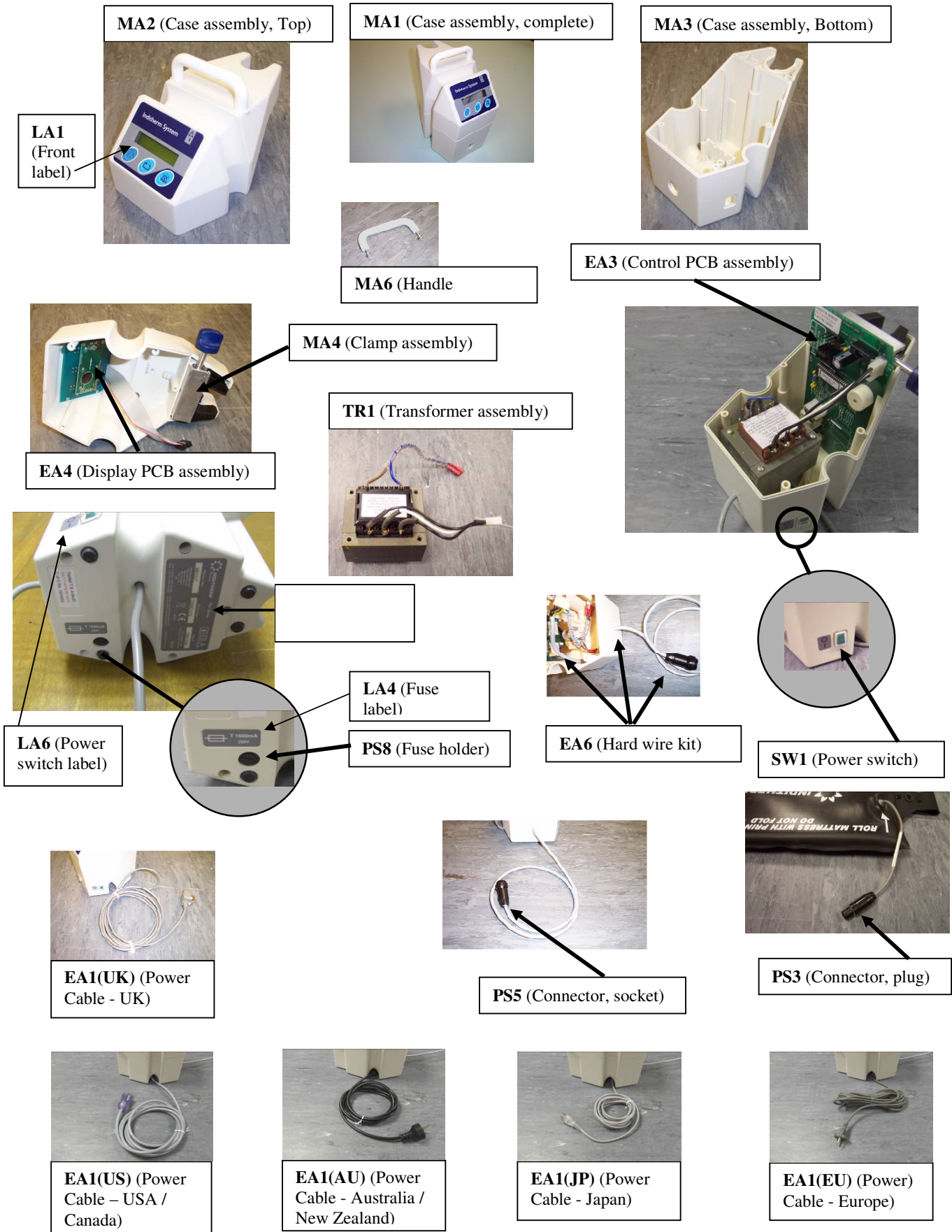



**Technical Specification:**

<b>Mattress Construction:</b>		<p>Inditherm® flexible polymer heating sheet, with 18mm viscoelastic foam pressure relief pad under and 205g.m<sup>-2</sup> expanded polyester comfort lining over.</p> <p>Encapsulated in latex-free, nylon fabric cover, with non-microporous polyurethane coating, fully sealed with RF welded seams.</p> <p>In-built temperature sensor and over-temperature thermal cut-out.</p> <p>Connection cable, 20 cm long, with strain relief, fully sealed entry grommet and IP61 rated waterproof connector.</p> <p>Sensors and cables let into pressure relief pad for patient comfort.</p>		
<b>Temperature Range:</b>		<p>37°C to 40°C (99°F to 104°F) in steps of 1°C (2°F)</p> <p>Over-temperature safety cut-out at 43°C (109°F)</p>		
<b>Power:</b>	<b>Control Unit:</b>	<p>230 Vac, ±6%, 50Hz, or 110 Vac, ±6%, 60Hz</p> <p>75 W</p>		
	<b>Mattresses &amp; Blankets:</b>	<p>24 Vac (nom.)</p> <p>25 W to 65 W, depending on size</p>		
<b>Dimensions:</b>	<b>Control Unit:</b>	<p>160 x 240 x 230 mm</p>		
	<b>Mattresses &amp; Blankets:</b>	<b>Type</b>	<b>Standard</b>	<b>Narrow</b>
		OTM1	1900 x 585 x 40 mm	1900 x 535 x 40 mm
		OTM2	1200 x 585 x 40 mm	1200 x 535 x 40 mm
		GTM1	1070 x 585 x 40 mm	1070 x 535 x 40 mm
		PTM1	560 x 500 x 40 mm	
		OTB	1070 x 500 x 40 mm	
		RB1	1660 x 800 x 40 mm	
		Other dimensions available on request		
	<b>Cable Length:</b>	<p>4 m</p>		
<b>Compliance:</b>		<p>EN60601-1, Class IIa, Type BF</p> <p>EN60601-2</p> <p>93/42/EEC, EEC Medical Devices Directive</p> <p>73/23/EEC, EEC Low Voltage Devices Directive</p>		
<b>Environmental:</b>				
	<b>Ambient Temperature (Operating):</b>	<p>15°C to 40°C (59°F to 104°F)</p>		
	<b>Ambient Temperature (Storage):</b>	<p>-10°C to 55°C (14°F to 131°F)</p>		
	<b>Relative Humidity:</b>	<p>30% to 70%</p>		